

FAIRWAY RAILING™

BY  **Envision™**
OUTDOOR LIVING PRODUCTS

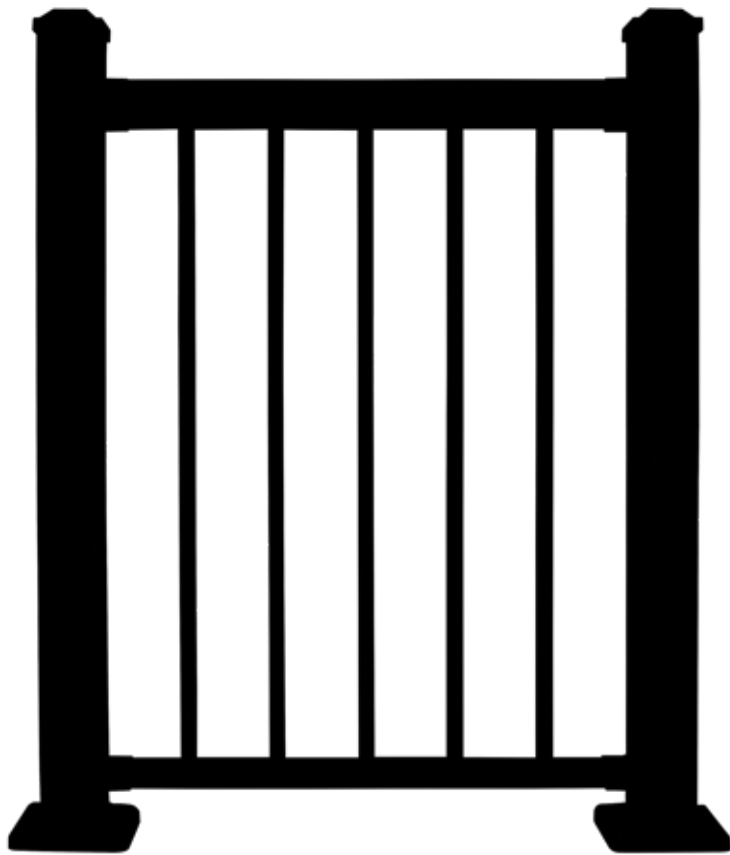

SQUARE ALUMINUM BALUSTERS

DESIGNER ALUMINUM RAILING INSTALLATION QUICK GUIDE

LEVEL & STAIR* KIT INCLUDES:

- Top Rail
- Sub-Rail with Rail Insert

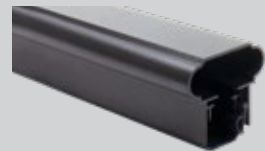

- Bottom Rail with Rail Insert



- Top Rail Connector Brackets with Screws
- Bottom Rail Connector Brackets with Screws
- Rail Support(s)
- Square Balusters
- Installation Template
(*not included in stair kit)

TOOLS NEEDED:

- Drill with #2 Square Drive Bit
- Circular Saw
- Speed Square
- Tape Measure
- Drill Extension

DESIGNER ALUMINUM LEVEL INSTALLATION

BEFORE STARTING

- Review all local building codes.
- Wear proper safety equipment.

STEP 1 GETTING STARTED

- Plumb all posts or mounting surfaces. Do not install post trim at this time. Post trim should be installed at completion of railing installation.
- Determine required bottom rail height from deck surface to bottom of rail based on local building codes.

STEP 2 INSTALL MOUNTING BRACKETS

- Insert brackets into template per desired rail height – middle bracket hole location for 36" high railing, top bracket hole location for 42" high railing.

STEP 3 CUT RAILS & INSTALL BOTTOM RAIL

- Measure distance between inside mounting brackets.
- Mark bottom rail to correct length.
- Ensure there is equal & maximum distance from baluster holes on both ends of top and bottom rails.
- Add 3/4" to bracket mark. Repeat for all top and bottom rail bracket marks.
- Cut bottom rail, top sub rail, and top cap rail the same length, ensuring baluster holes line up.
- Slide bottom bracket cover onto both sides of the rail and set rail into place. Secure rail by installing two #8 x 3/4" self-drilling screws through holes in both sides of each bracket. Snap bracket cover over the bracket.

STEP 4 INSERT BALUSTERS

- Insert balusters into bottom rail making sure they are fully seated into rail.
- Make sure that the "P" insert remains within the bottom rail channel.

STEP 5 INSTALL TOP RAIL & PANELS

- Holding the sub rail at an angle above the baluster, start at one end to insert first baluster and tap lightly.
- Insert remaining balusters making sure they are seated completely in both bottom and sub rails.
- Slide top bracket cover onto both sides of top rail. Place top cap rail over sub-rail.
- Secure rail by installing two #8 x 3/4" self drilling screws through holes in both sides of each bracket. Snap bracket cover over the bracket.

STEP 6 FINISHING STEPS

- Tap post caps in place.
- Install two-piece, snap together trim.
- Measure to the underside of the bottom rail and cut rail support to measured length.
- Measure to the center of the bottom rail and secure rail support with 3/4" stainless steel screw.

STEP 2

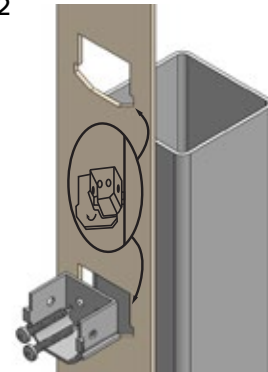

STEP 3

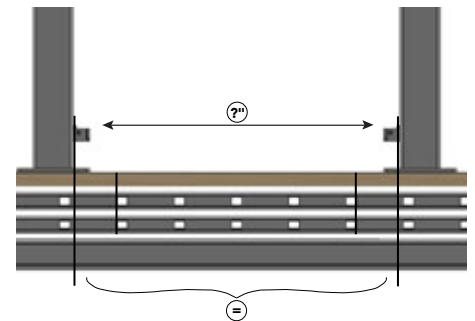

STEP 4

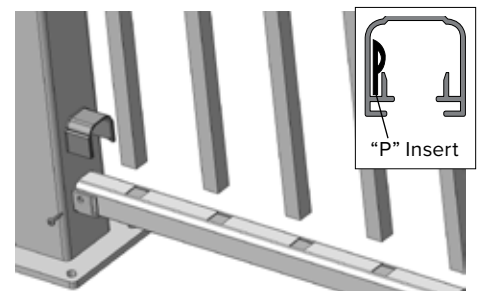

STEP 5

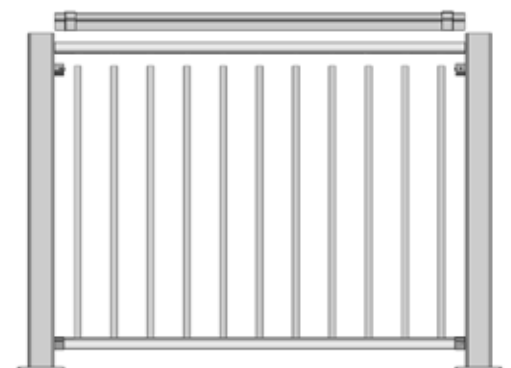

It is the responsibility of the installer to meet or exceed all code and safety requirements, and to obtain all required building permits. These instructions are only a guide and may not address every circumstance. The installer should determine and implement appropriate installation techniques for each situation. Envision Outdoor Living Products shall not be held liable for improper or unsafe installations.

DESIGNER ALUMINUM STAIR INSTALLATION

BEFORE STARTING

- Review all local building codes.
- Wear proper safety equipment.

STEP 1 GETTING STARTED

- Plumb all posts or mounting surfaces.
Do not install post trim at this time. Post trim should be installed at completion of railing installation.
- Determine required bottom rail height from deck surface to bottom of rail based on local building codes.

STEP 2 MARK & CUT RAILS

- Use blocking to achieve desired rail sweep height.
- Lay bottom rail onto blocking next to post and clamp using a quick clamp.
- Balance out baluster end spacing for equal distance at top and bottom of stairs.
- Place one baluster in each end hole and place the sub-rail on top.
- Make sure balusters are parallel to the posts and clamp the sub-rail to each post.
- Hold brackets on post next to rail and mark rail at all bracket locations.
- Unclamp railing section from post.
- Add 3/4" to bracket mark. Repeat for all top and bottom rail bracket marks.
- Transfer top sub-rail measurement to top cap rail.
- Cut all marks at 90° angle and slide bottom brackets onto ends of rail.

STEP 3 INSTALL BRACKETS & RAIL SECTION

- Place bottom rail onto blocking between posts and pre-drill bracket holes using a 1/8" drill bit.
- Secure rail using the provided 1-1/2" stainless steel screws.
- Insert balusters into bottom rail making sure they are fully seated.
- Insert sub-rail into the top cap rail and slide brackets and tap lightly.
- Starting at the top of the stairs, insert first baluster.
- Insert remaining balusters making sure they are fully seated in the bottom and top rail.
- Pre-drill bracket holes using 1/8" bit and secure with 3/4" stainless steel screw.

STEP 4 FINISHING STEPS

- Tap post caps in place.
- Install two-piece snap-together trim.

STEP 1



STEP 2

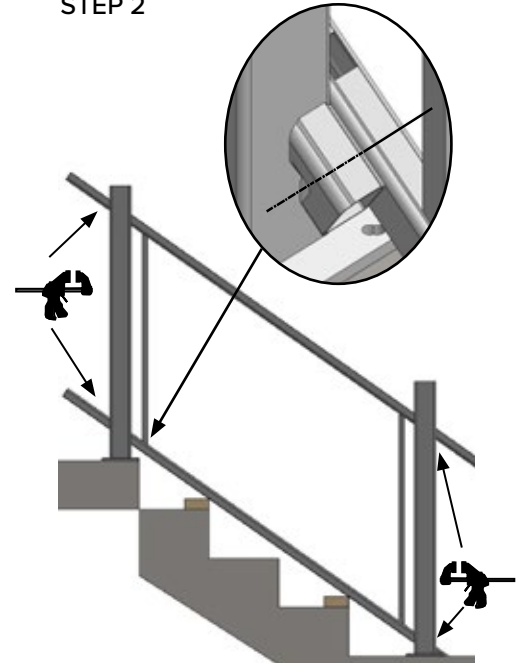

STEP 3

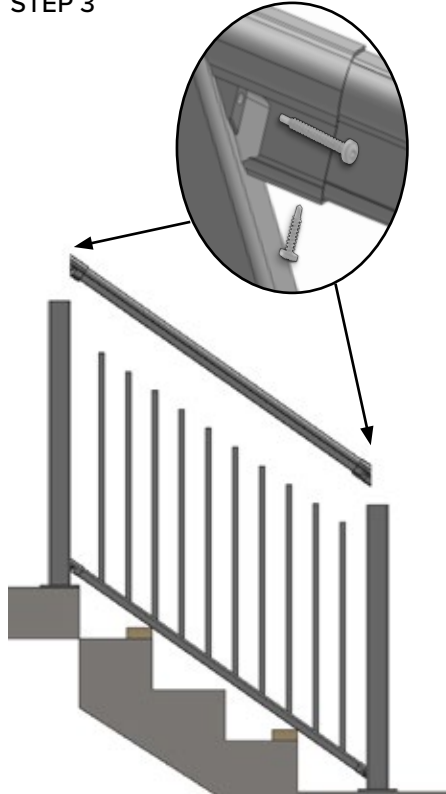

STEP 4

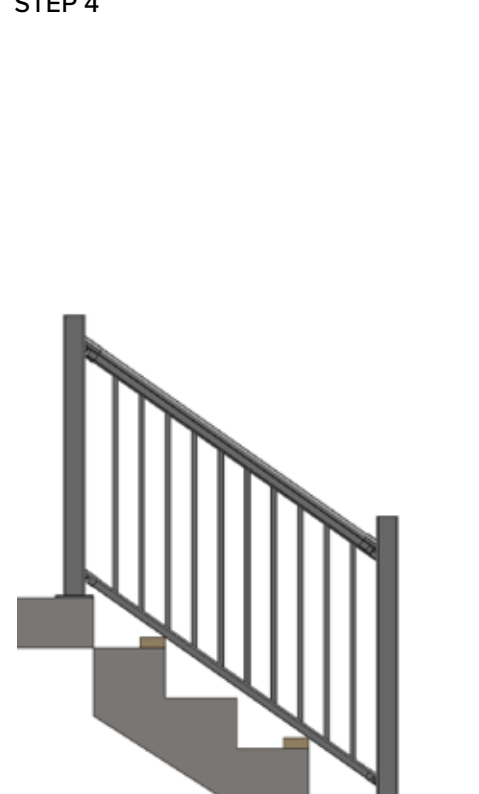

It is the responsibility of the installer to meet or exceed all code and safety requirements, and to obtain all required building permits. These instructions are only a guide and may not address every circumstance. The installer should determine and implement appropriate installation techniques for each situation. Envision Outdoor Living Products shall not be held liable for improper or unsafe installations.

